









version Exterior

- 1** Reinicia la hora y día
- 2** Elimina la programación
- 3** Fusible de 0,75
- 4** Pilas
- AUTO**
-  Trabaja
- SET**
-  Hora actual
-  Hora de inicio
-  Duración zona
-  Frecuencia
- OFF**
-  Off
- MANUAL**
- Riego manual
- EXTRA**
- Extra
- BUDGET**
- Budget
-   Más y menos
-  Confirma
- Sensor** Entrada del sensor de lluvia
- C - C** Entrada comun
- m** Bomba

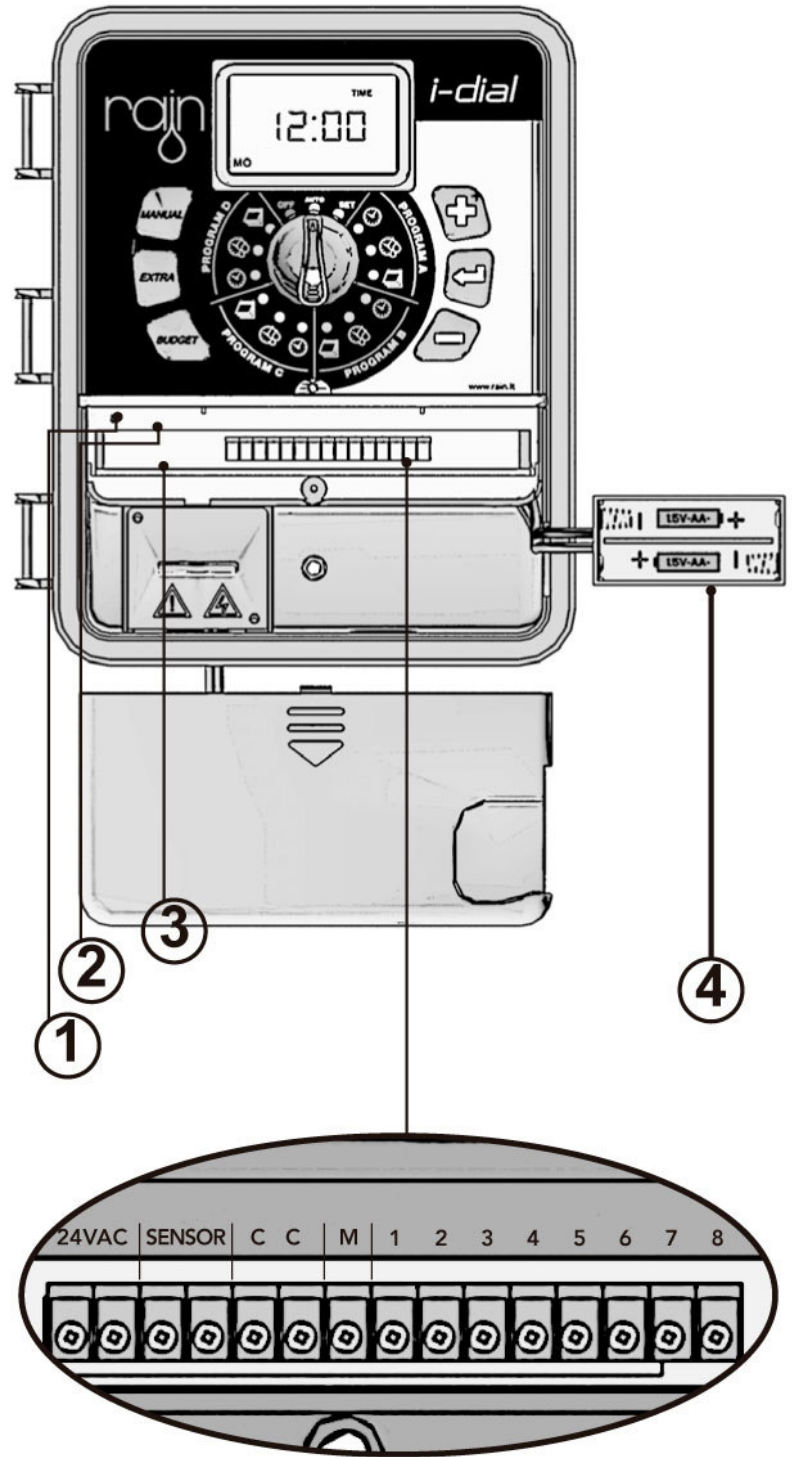

Batteries OUTDOOR

Pilas

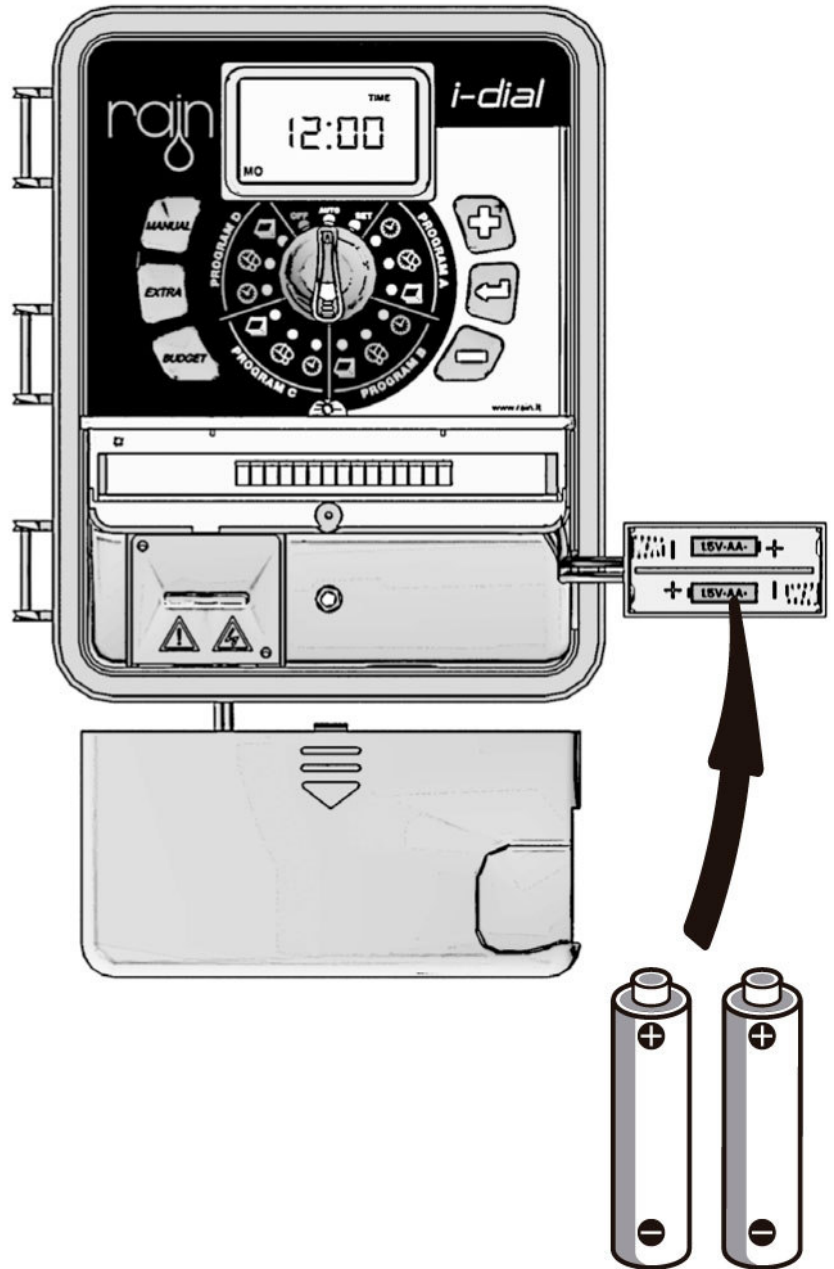

AA 1.5V x 2

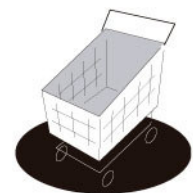

Connections: solenoid valves

Conexiones

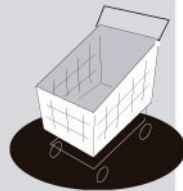
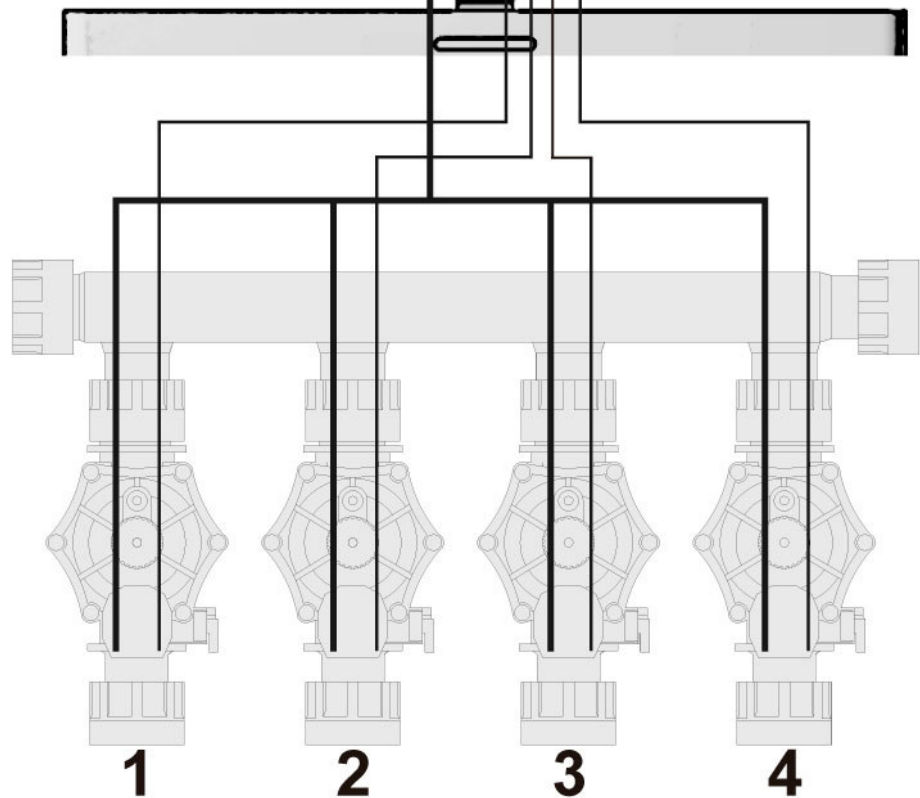
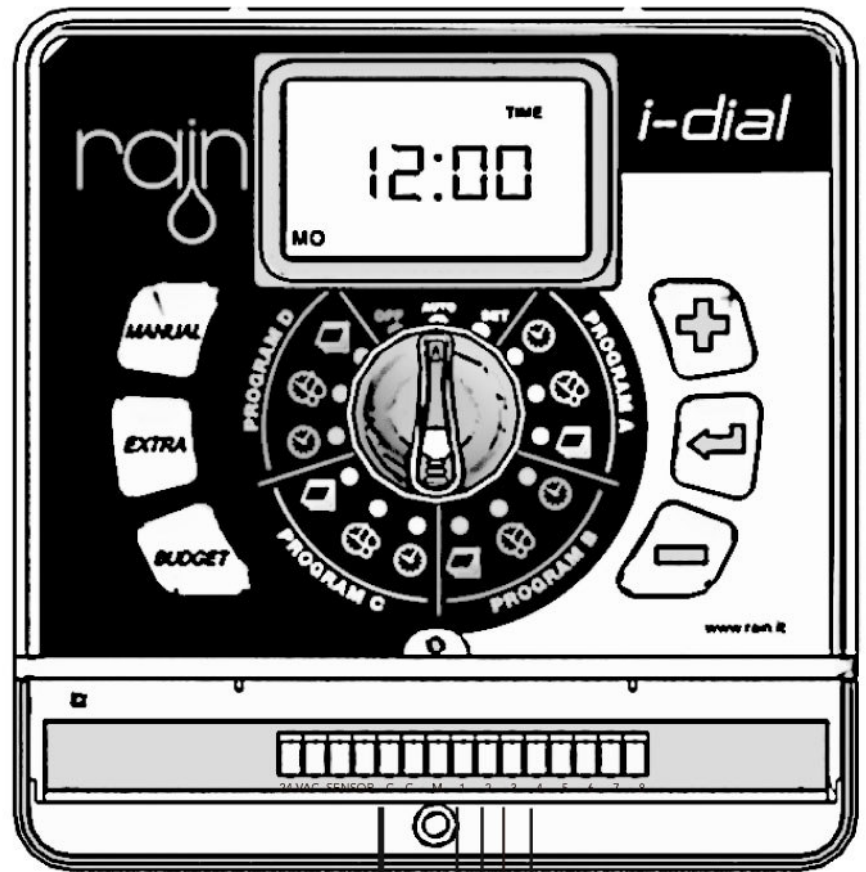

Connections: rain sensor

Conexiones

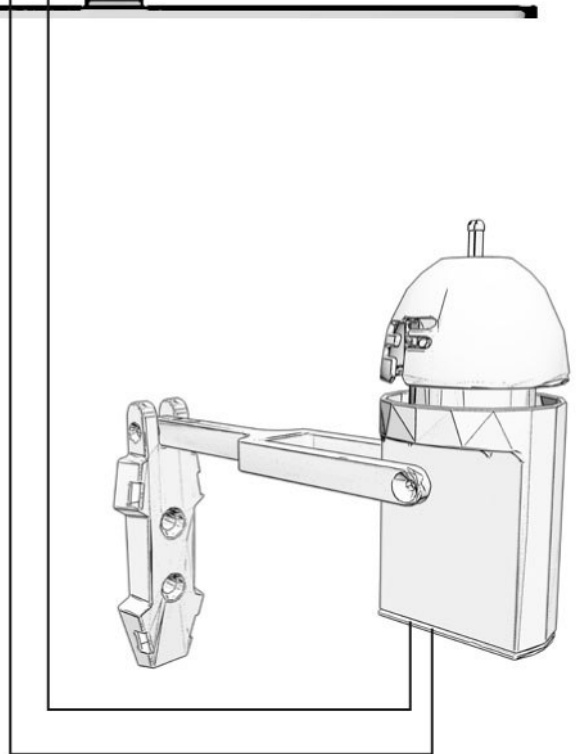

Rain Sensor

Sensor de lluvia

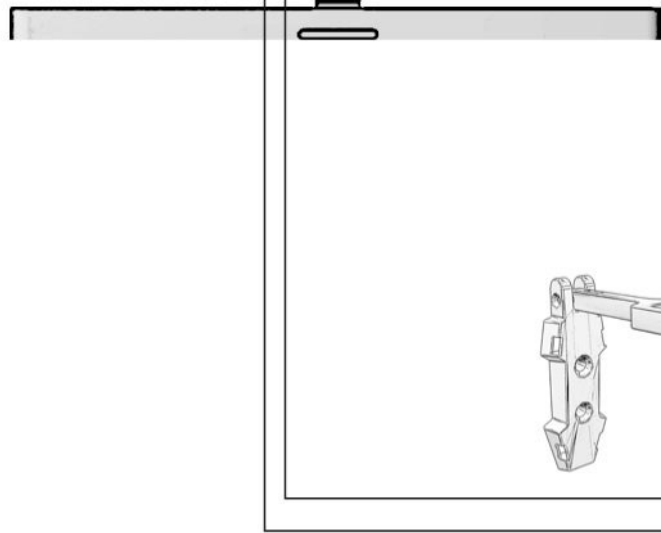

Connections: pump

Bomba

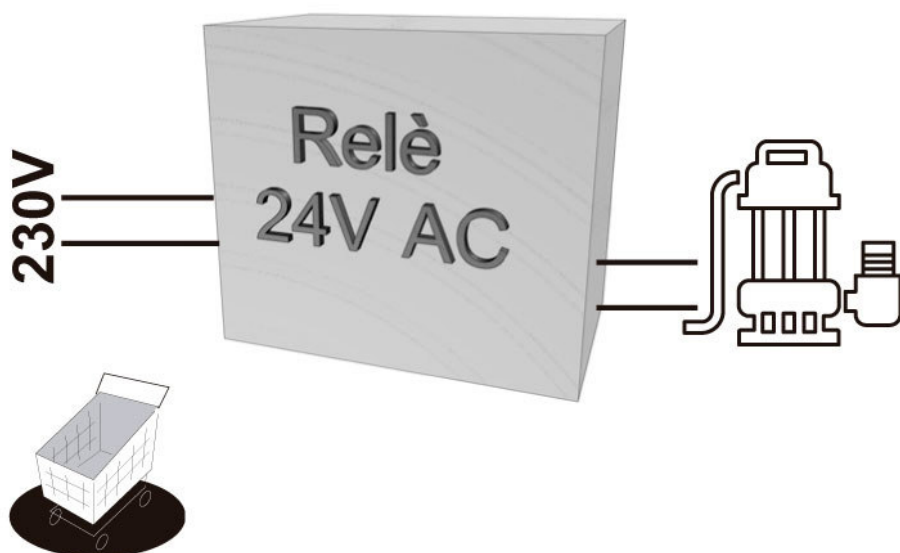
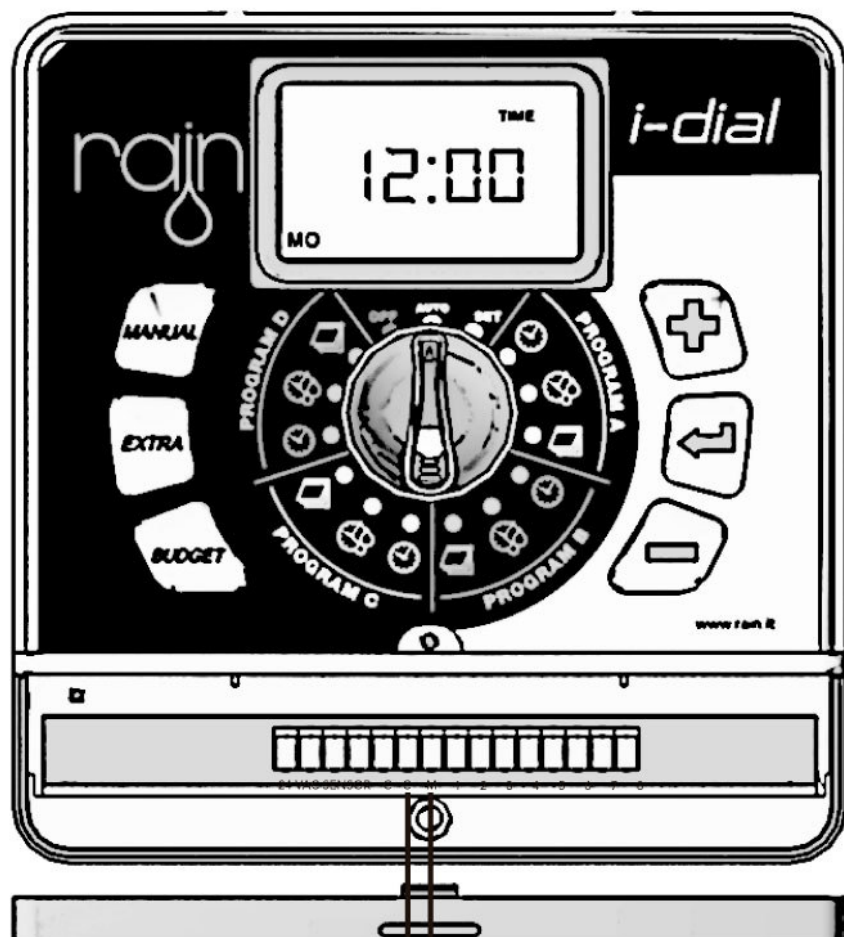

Connections OUTDOOR

Transformador

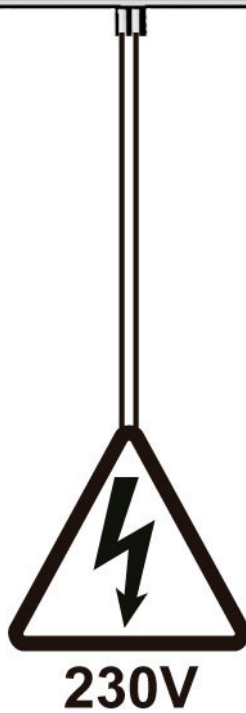
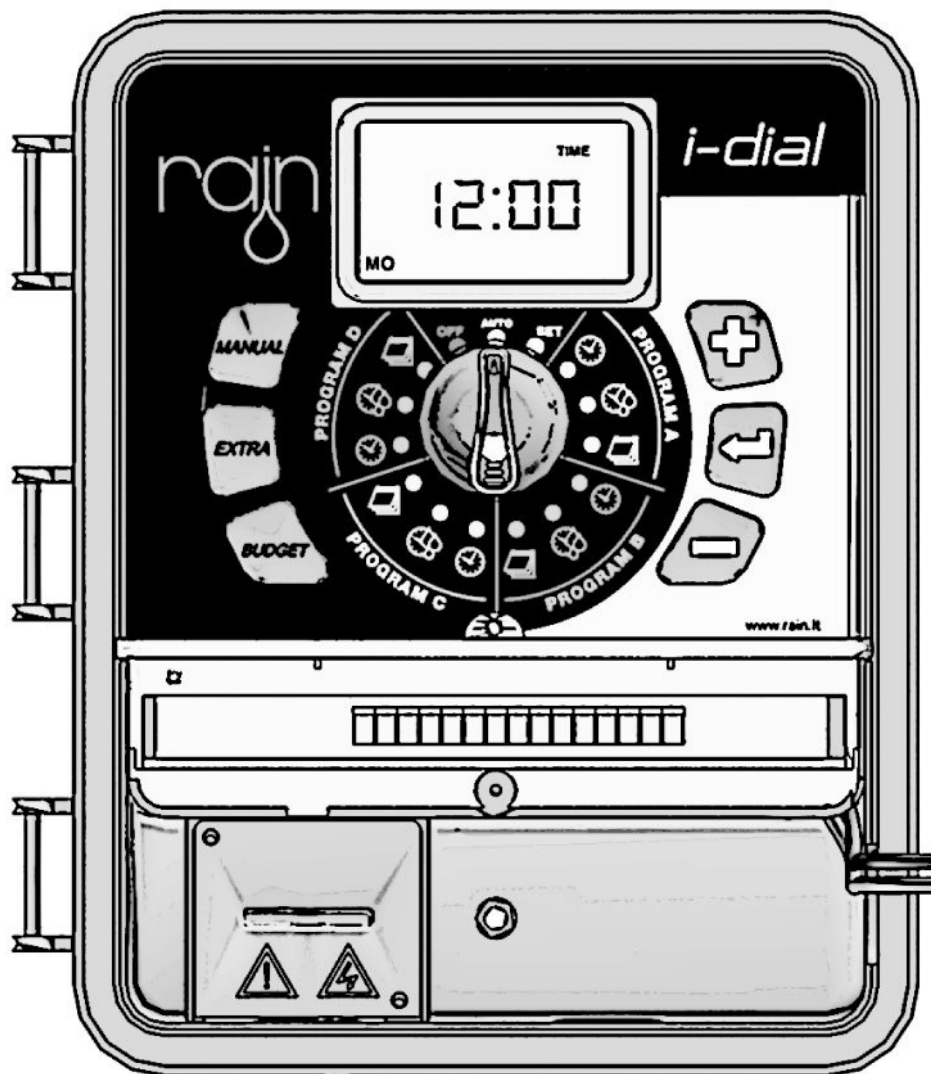

ES-OUTDOOR



NOTA: La conexión del I-DIAL de exterior a la alimentación principal de CA sólo deberá realizarla un electricista cualificado conforme a la normativa local. La instalación incorrecta podría causar descargas eléctricas o riesgo de incendio.

Current
time

Hora actual



+



+



+



+



+



Start Time

Hora de inicio

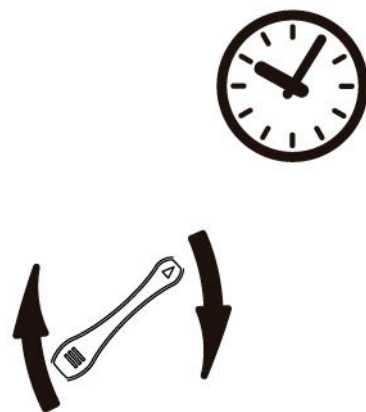
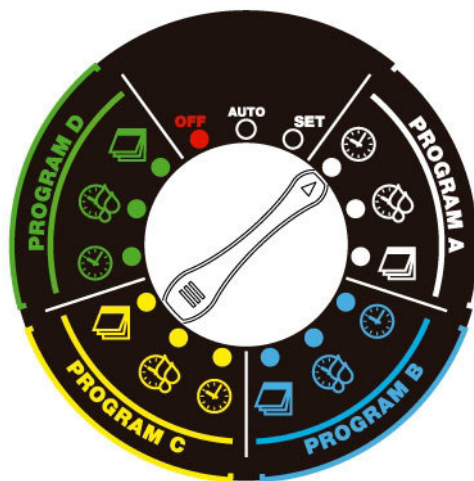

+

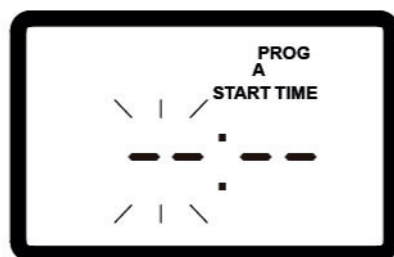

+



+

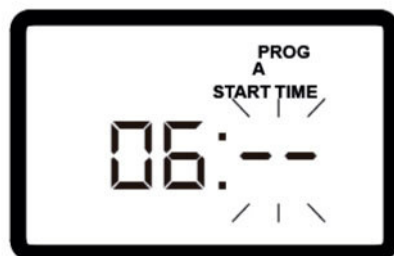

Duration

Duración

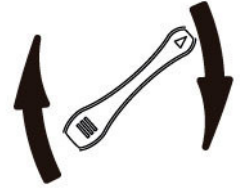
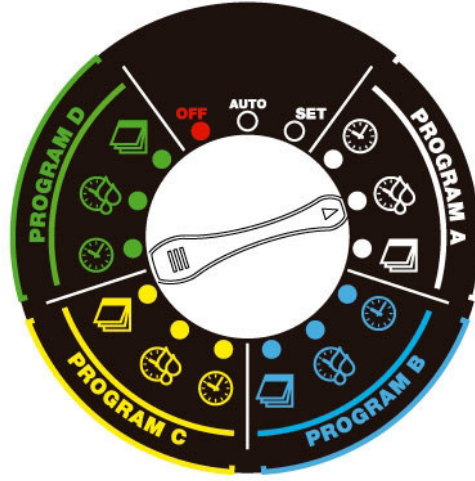

+



Min | Max
1 min | 240 min

+



2
3

...



·
·
n

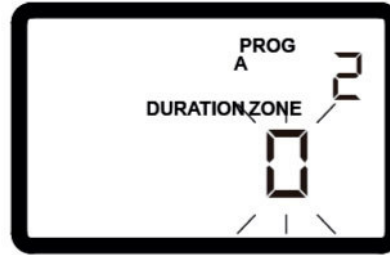
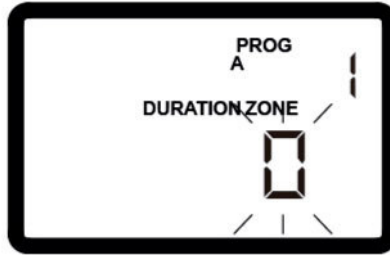

Frequency: days of week

Frecuencia

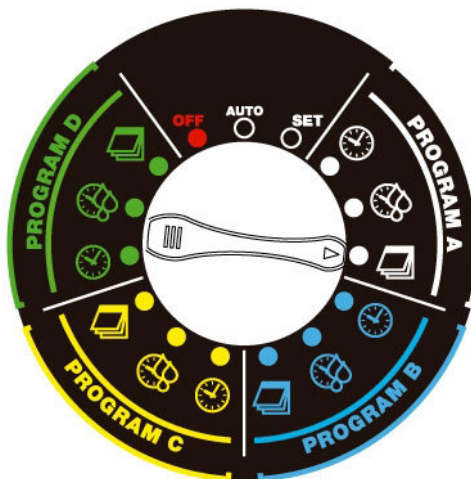

MO = ON

TU = OFF

WE = OFF

TH = ON

FR = ON

SA = OFF

SU = OFF

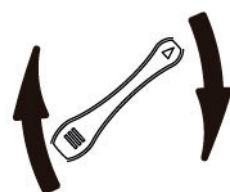

+



ON



OFF

+

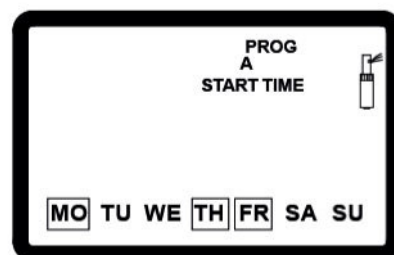

Frequency: by interval

Frecuencia

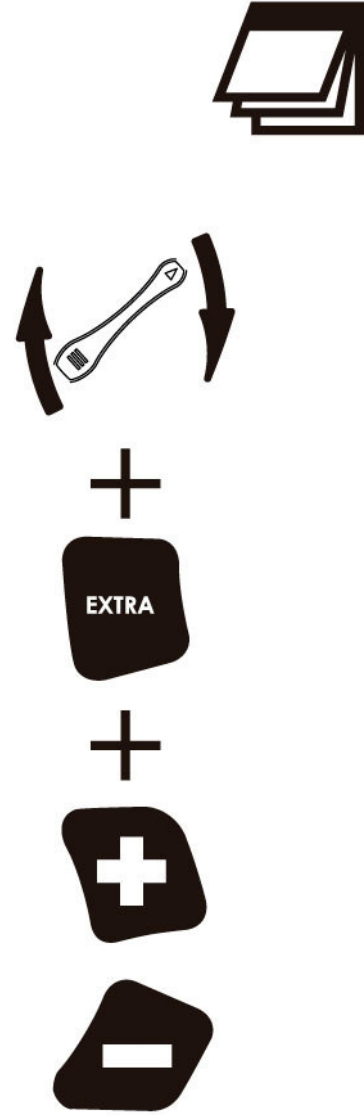
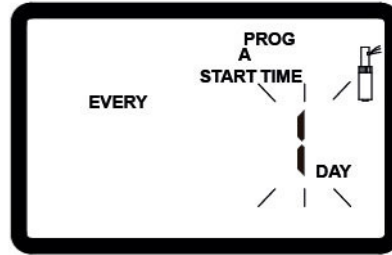
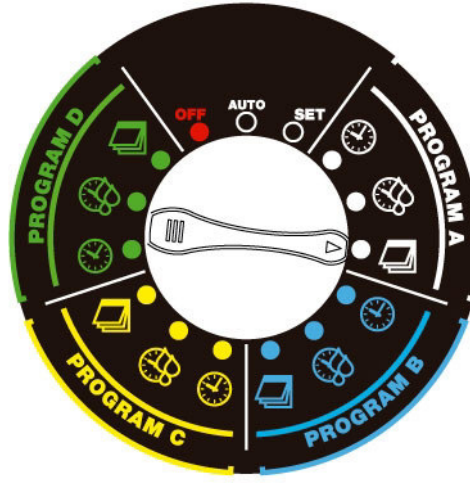

1 Day



2 Day



3 Day



Min | **Max**
1 Day | **19 Days**



Manual start: all zones

Riego manual

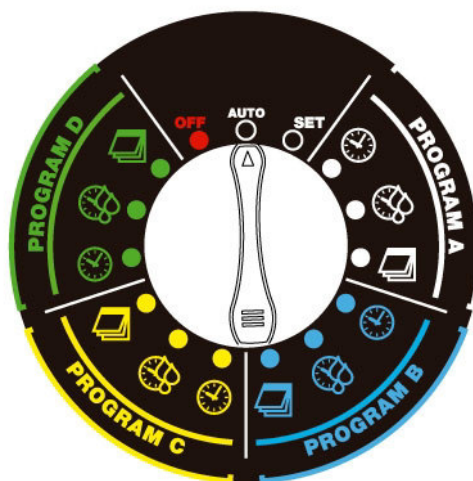

Zone 1 = 3 min

Zone 4 = 3 min

Zone 2 = 3 min

Zone 5 = 3 min

Zone 3 = 3 min

Zone 6 = 3 min

Manual OFF

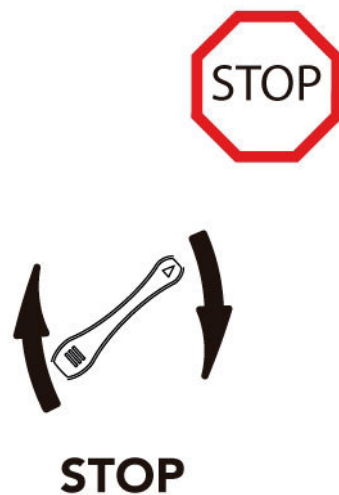

Manual start: by zone

Riego manual

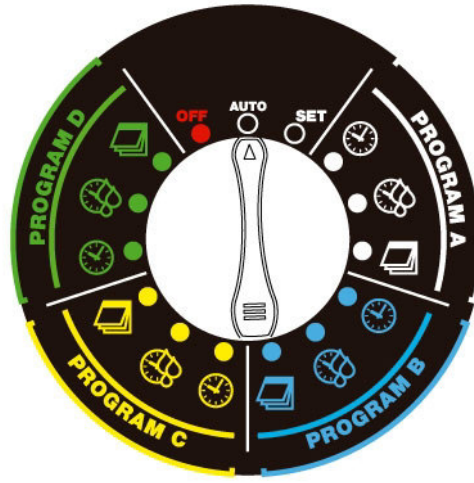

+



+



+



2
3
.
.
.
n

Manual OFF



STOP



Budget

Budget

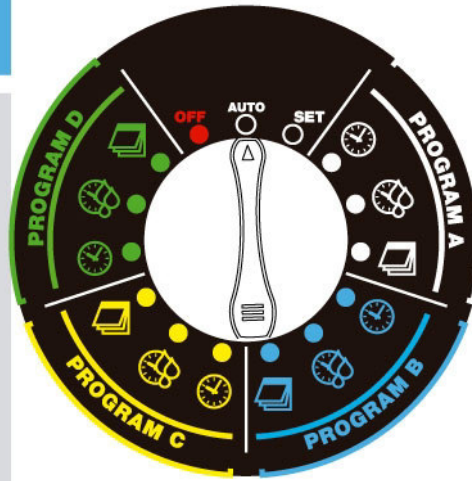

%



+



Min | Max
10 % | 200 %



10 min > 200% > 20 min



10 min > 100% > 10 min



10 min > 10% > 1 min



Pump

Bomba



ON



OFF



•

•

•



2

3

•

•

•

n



Conexiones

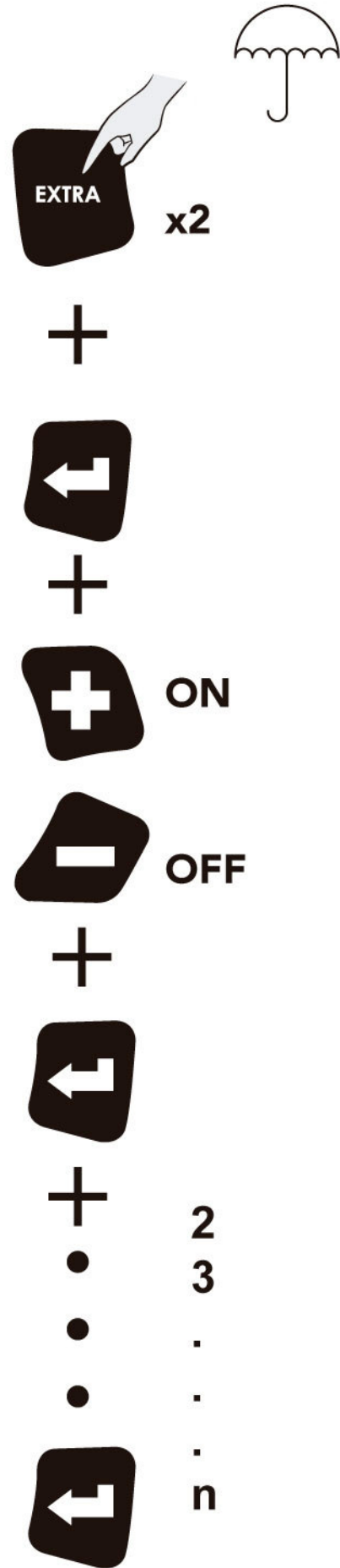
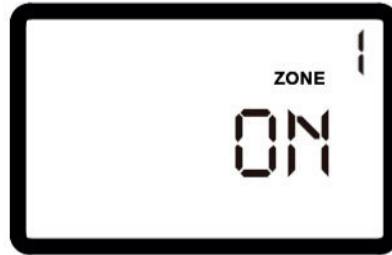
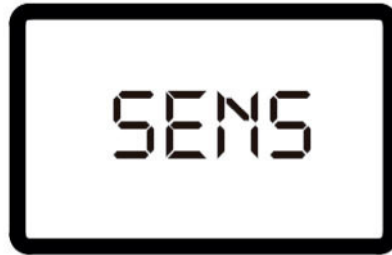
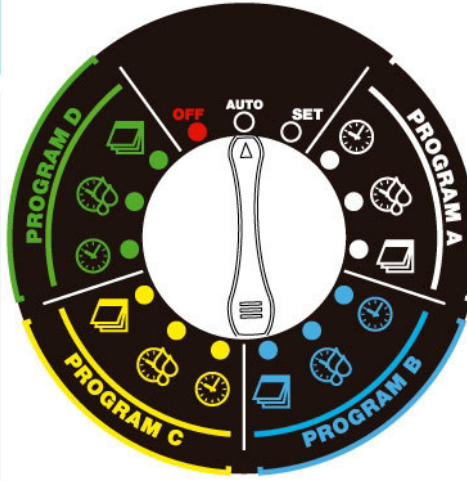

OFF

Off/on



Low Battery

Batería baja

